

GATE VALVES

BRASS GATE VALVE

5230

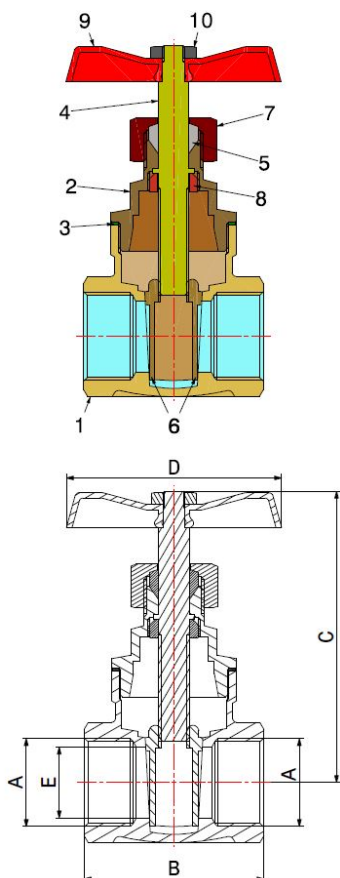

- Brass gate valve light model
- Thread ISO 228
- Temperature range max 80°C

Valve suitable for distributing and interrupting fluids that are generally non-corrosive, compatibly with the valve materials. Plumbing, heating, industrial and agricultural sectors are the ideal fields of application.

The seat tightness is guaranteed by a metal-to-metal seal.

COMPONENTS

POS.	PART NAME	N°	MATERIAL
1	Body	1	CW617N UNI-EN 12165 (until 2") - C EN1982 CB754S (from 2.1" to 4")
2	Upper part	1	CW617N UNI-EN 12164
3	Gasket	1	Guarnital fiber
4	Stem	1	CW617N UNI-EN 12164
5	Gasket	1	Dutral EPDM 90
6	Disc	2	C EN1982 CB 754S
7	Gland	1	CW617N UNI-EN 12164
8	Ring nut	1	CW617N UNI-EN 12164
9	Handwheel	1	Red epoxy-resin plasticized steel
10	Nut	1	Galvanised iron

DIMENSIONS

DN	A	B	C	D	E	PN
10	3/8"	33	67	45	13	10
15	1/2"	35	68	45	13	10
20	3/4"	39	68	45	15	10
25	1"	43	77	50	19	10
32	1.1/4"	47	92	55	27	10
40	1.1/2"	53	107	60	33	10
50	2"	57	130	70	45	10
65	2.1/2"	63	146	80	47	10
80	3"	70	175	100	60	10
100	4"	80	194	100	71	10

PACKAGING

	3/8"	1/2"	3/4"	1"	1.1/4"	1.1/2"	2"	2.1/2"	3"	4"
CODE	52300003	52300004	52300006	52300008	52300010	52300011	52300013	52300015	52300017	52300019
PCS BOX	20	20	20	20	10	10	5	-	-	-
PCS CARTON	160	160	160	100	60	50	30	20	16	10