

BALL VALVES

RENO - INCHES

1300

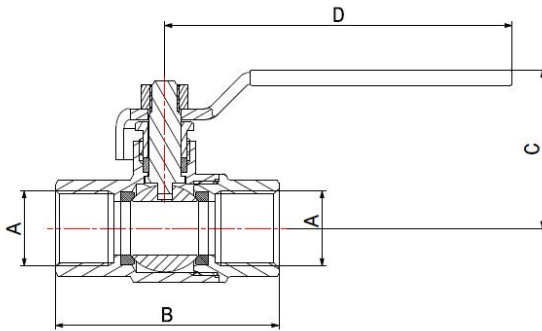
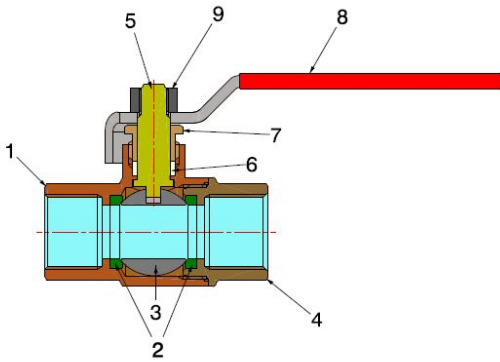

COMPONENTS

POS.	PART NAME	N°	MATERIAL
1	Body	1	CC491K UNI-EN 1982:2000
2	Seal	2	PTFE
3	Ball	1	CW617N UNI-EN 12165 chrome-plated
4	End connection	1	CC491K UNI-EN 1982:2000
5	Stem	1	CW617N UNI-EN 12164
6	Gland packing	1	PTFE
7	Gland	1	CW617N UNI-EN 12164
8	Lever	1	Galvanised iron and PVC coated
9	Nut	1	Galvanised iron

DIMENSIONS INCHES

A	B	C	D	PSI
1/4"	2,008	1,870	3,346	500
3/8"	2,008	1,870	3,346	500
1/2"	2,441	1,771	3,346	500
3/4"	2,756	2,264	4,094	500
1"	3,346	2,264	4,094	500
1.1/4"	3,898	2,953	4,803	500
1.1/2"	4,331	3,051	4,803	500
2"	5,275	3,661	6,024	500
2.1/2"	5,950	4,705	7,874	400
3"	7,008	5,276	11,024	400
4"	8,268	6,043	11,024	400

PACKAGING

	1/4"	3/8"	1/2"	3/4"	1"	1.1/4"	1.1/2"	2"	2.1/2"	3"	4"
CODE	13000102R	13000103R	13000104R	13000106R	13000108R	13000110R	13000111R	13000113R	13000115R	13000117R	13000119R
PCS BOX	30	25	20	12	8	-	-	-	-	-	-
PCS CARTON	150	175	120	72	48	30	25	10	8	4	2